

Western Electric Company, Inc.  
 Telephone Sales Division - Excl. Inst.  
 Engineer of Shops

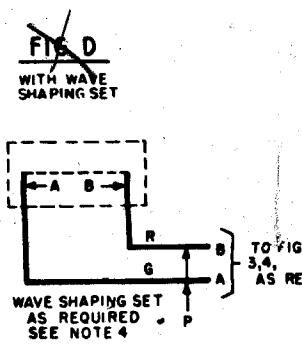

28C TELETYPEWRITER-BASE

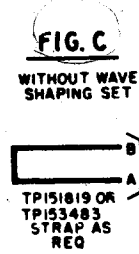

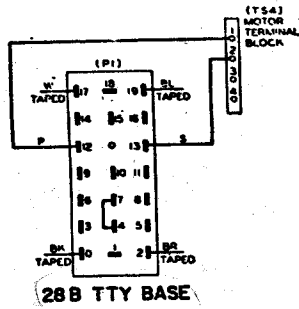
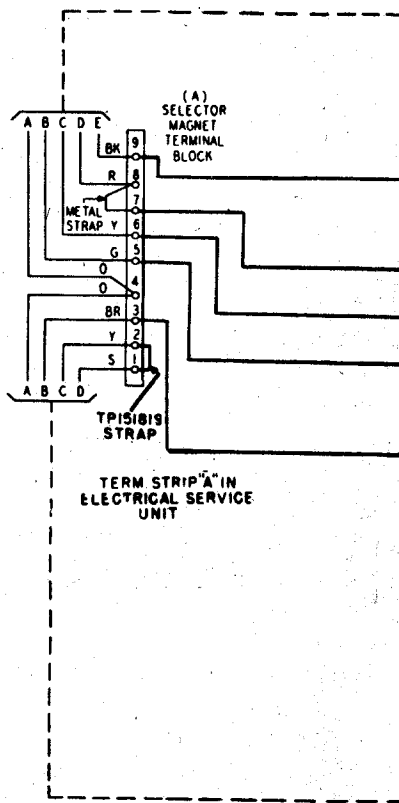
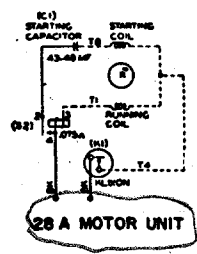
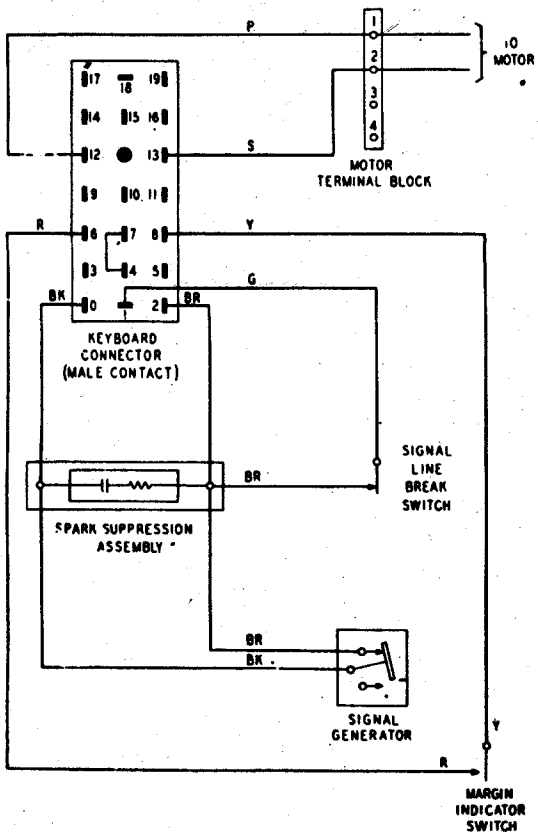



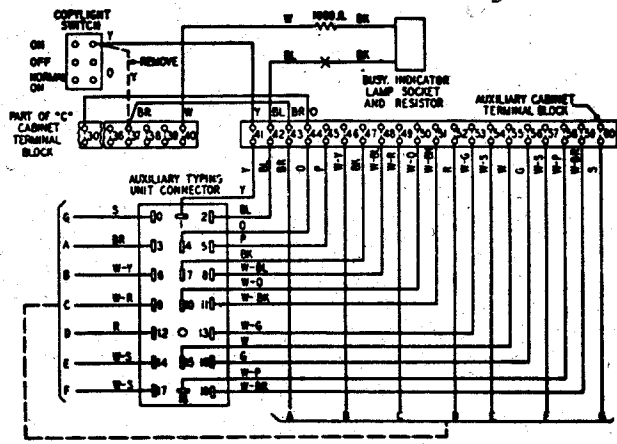

MODIFICATION OF WIRING OF 28 TTY CABINET USING PARTS FURNISHED WITH 28 TYPE TYPING UNITS

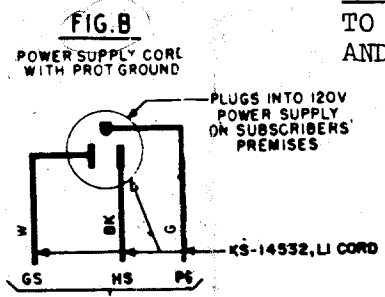

TO FIG. 1

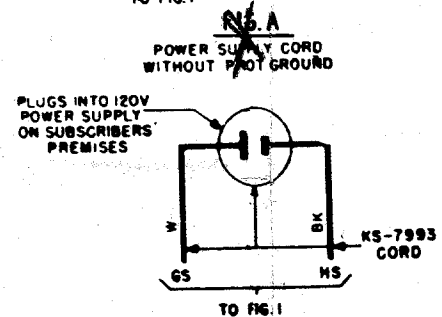

TO FIG. 1

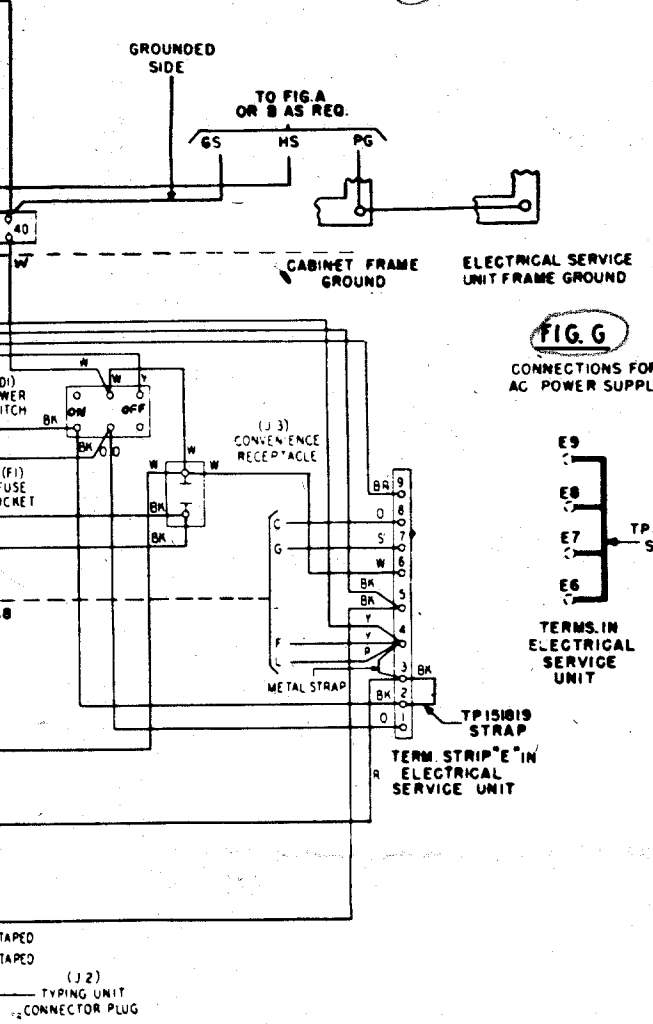
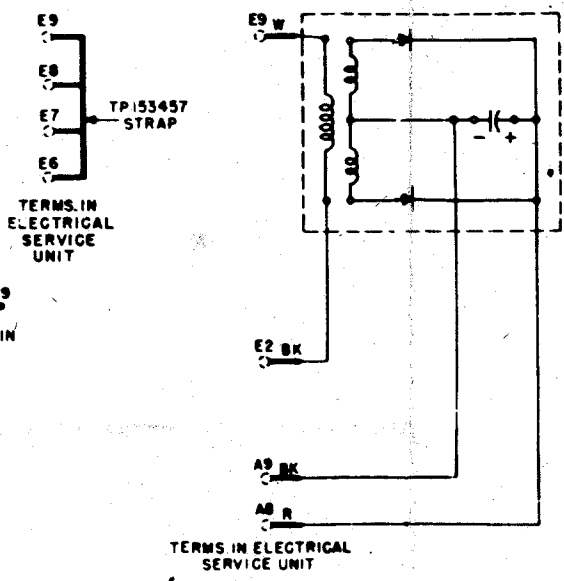

FIG. G CONNECTIONS FOR AC POWER SUPPLY

FIG. H TP152950 RECTIFIER ASSEMBLY



TERMS IN ELECTRICAL SERVICE UNIT

CHANGE FROM PREVIOUS ISSUE TO INCLUDE WIRING FOR POSITIVE BATTERY AND NEGATIVE BATTERY AT TTY TO LINE.

WIRING PLAN 28 TYPE TELETYPEWRITER STATIONS-PRIVATE LINE SERVICE-SEND AND OR RECEIVING ONLY-RELAY OPERATION-ON POLAR OR NEUTRAL, 2W LINE OR 1W LINE GROUND OR BATTERY, SWITCH CONTROL-WA SET-TIME SWITCH-AC OPERATION.

- NOTES:
1. WIRE MAN SHALL LINE OUT ALL FIG. 2 WIRING PLAN WHICH ACCOMPANIES THIS PLAN.
  2. CANCELLED.
  3. UNLESS OTHERWISE SPECIFIED ALL LEADS SHALL BE 22GA BROWN, TYPE A. T. & T. CO. SPEC. 7039.
  4. THE A & B LEADS SHALL BE CONNECTED TO THE SHAPING SET AS SPECIFIED ON THE DRAWING (P30.620).
  5. ADD TP151819 STRAP ON TERMINAL BLOCK ONLY SERVICE AND STRAP KO-K1 ON THE DRAWING.
  6. REMOVE STRAPS FROM TERMS 21-40 ON THE DRAWING.
  7. LINE AND GROUND CONNECTIONS SHOWN IN FIG. 2, 3, 4, 5, 6, 7, 8, 9, 10, 11, 12, 13, 14, 15, 16, 17, 18, 19, 20, 21, 22, 23, 24, 25, 26, 27, 28, 29, 30, 31, 32, 33, 34, 35, 36, 37, 38, 39, 40, 41, 42, 43, 44, 45, 46, 47, 48, 49, 50, 51, 52, 53, 54, 55, 56, 57, 58, 59, 60, 61, 62, 63, 64, 65, 66, 67, 68, 69, 70, 71, 72, 73, 74, 75, 76, 77, 78, 79, 80, 81, 82, 83, 84, 85, 86, 87, 88, 89, 90, 91, 92, 93, 94, 95, 96, 97, 98, 99, 100.

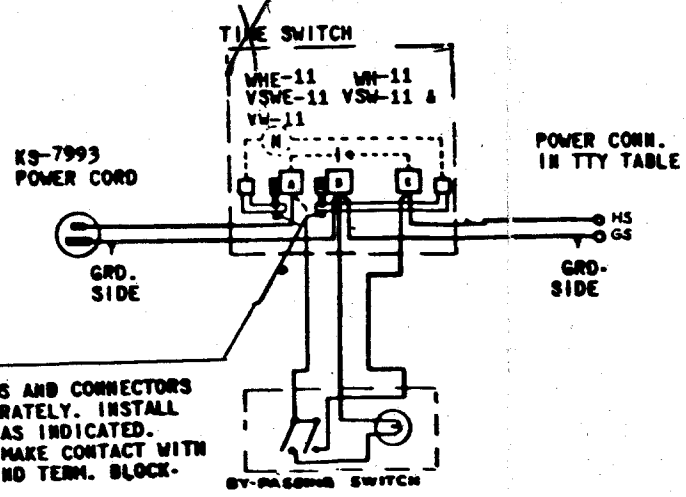

MACHINE SCREWS AND CONNECTORS PROVIDED SEPARATELY. INSTALL IN TERMINALS AS INDICATED. THESE SCREWS MAKE CONTACT WITH BUS BARS BEHIND TERM. BLOCK.

BY-PASSING SWITCH

CHANGE FROM PREVIOUS ISSUE

TO INCLUDE WIRING FOR POSITIVE BATTERY AND NEGATIVE BATTERY AT TTY TO LINE.

TP581.000  
BOOK 4C  
CODE W0470

Sheet 1 of 2  
3-25-59  
Repl. Iss. 7-12-57

**WIRING PLAN 28 TYPE TELETYPEWRITER STATIONS-PRIVATE LINE SERVICE-SEND AND RECEIVE OR RECEIVING ONLY-RELAY OPERATION-ONE WAY POLAR OR NEUTRAL, 2W LINE OR 1W LINE TO GROUND OR BATTERY, SWITCH CONTROL-WAVE SHAPING SET-TIME SWITCH-AC OPERATION.**

967

REQ. NO. <i>Machanic</i>
SHOP ORDER NO.

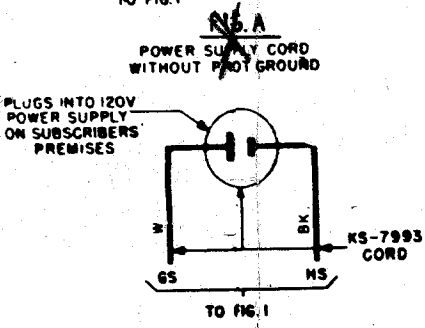
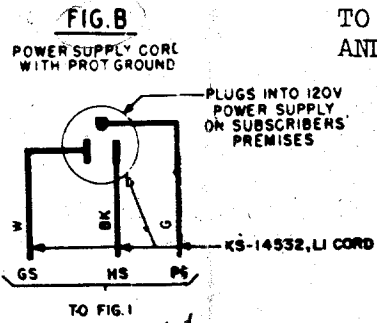

**FIG. H**  
TP152950 RECTIFIER ASSEMBLY

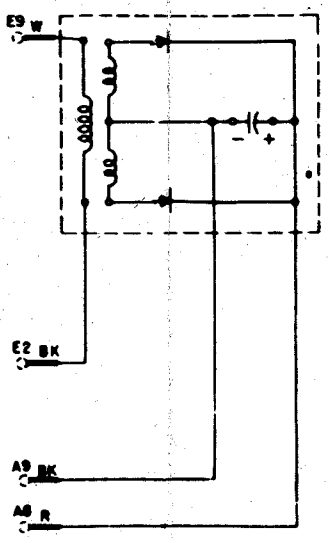

TERMS IN ELECTRICAL SERVICE UNIT

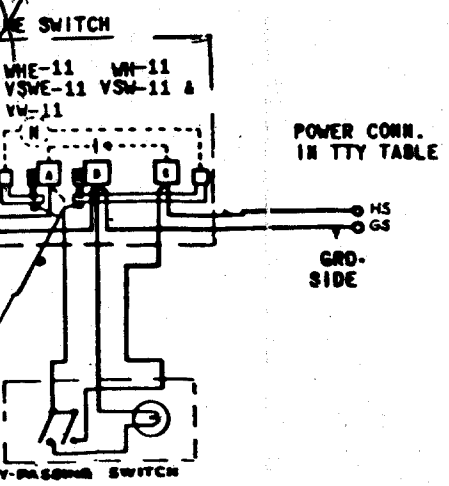

**NOTES:**

1. WIRE MAN SHALL LINE OUT ALL FIGURES NOT USED ON COPY OF WIRING PLAN WHICH ACCOMPANIES STATION.
2. CANCELLED.
3. UNLESS OTHERWISE SPECIFIED ALL COLOR CODED INTERCONNECTING LEADS SHALL BE 22GA BROWN, TYPE GS STATION WIRE PER A.T. & T. CO. SPEC. 7039.
4. THE A & B LEADS SHALL BE CONNECTED TO TERMINALS ON WAVE SHAPING SET AS SPECIFIED ON THE LT WIRING PLAN (SEE BSP P30.620).
5. ADD TP151819 STRAP ON TERMINALS C-9 AND C-11 FOR RECEIVE ONLY SERVICE AND STRAP KO-KI ON 28B BASE.
6. REMOVE STRAPS FROM TERMS 21-40 AND 22-35.
7. LINE AND GROUND CONNECTIONS SHALL BE MADE PER FIG. 2, ~~8 OF 1~~.

CHANGE FROM PREVIOUS ISSUE  
TO INCLUDE WIRING FOR POSITIVE BATTERY  
AND NEGATIVE BATTERY AT TTY TO LINE.

Fig. 5

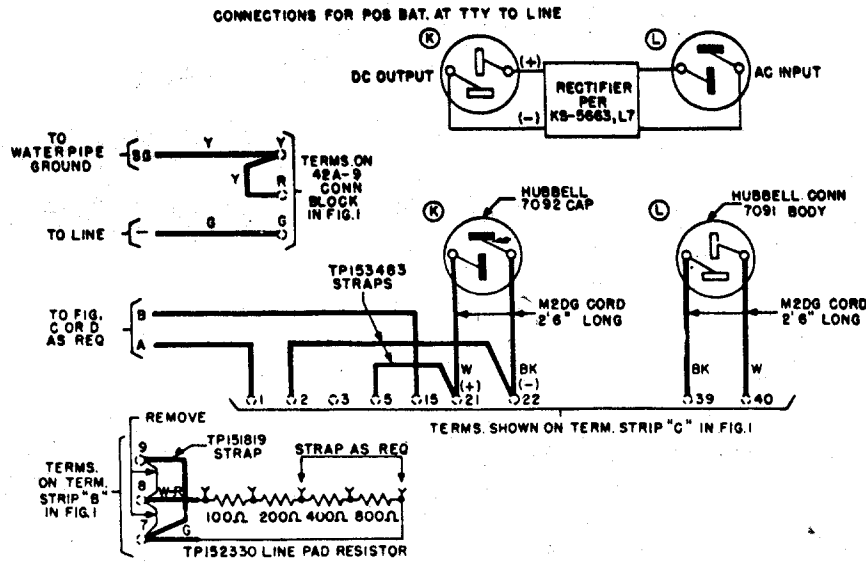

FIG. 6

