

WO470
SHEET B1

FS2

PART OF 28F

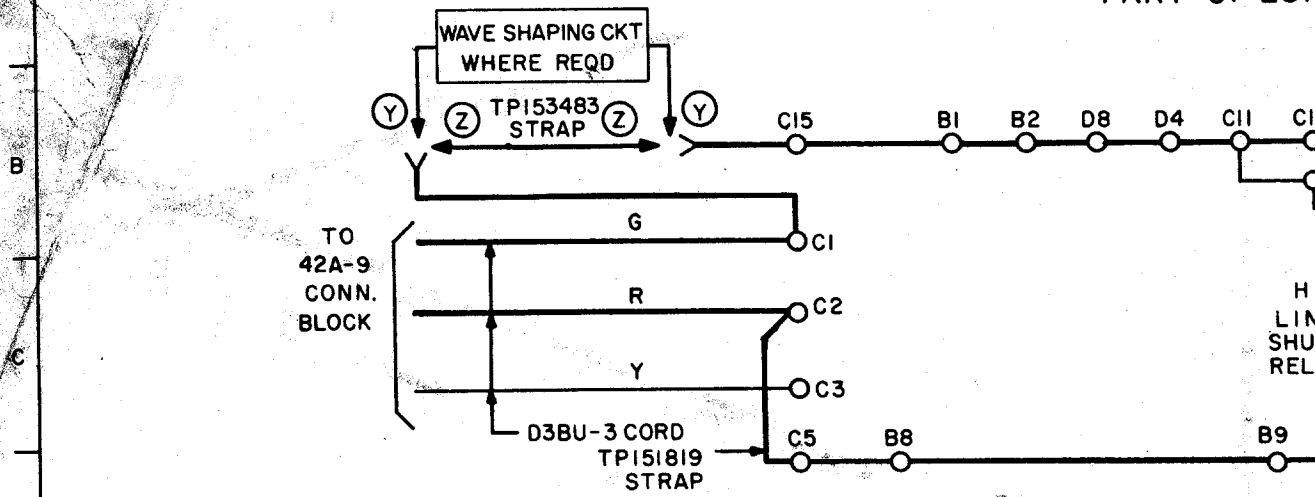

FS3

PART OF 28KSF
LINE TEST K

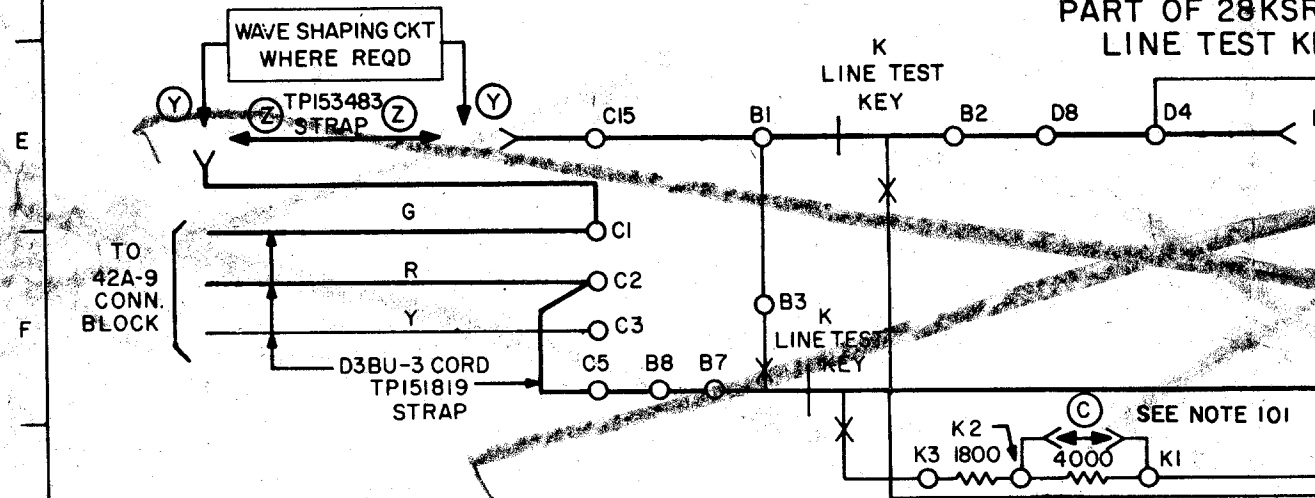

FS4

PART OF 28K
LESS LINE TEST

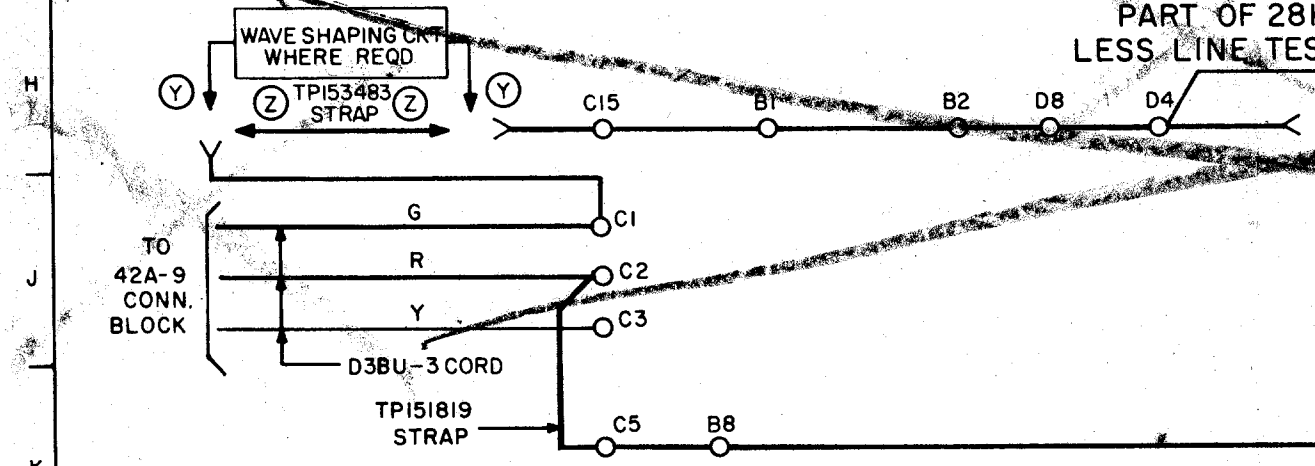

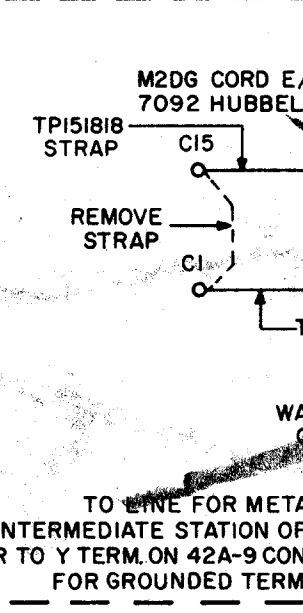
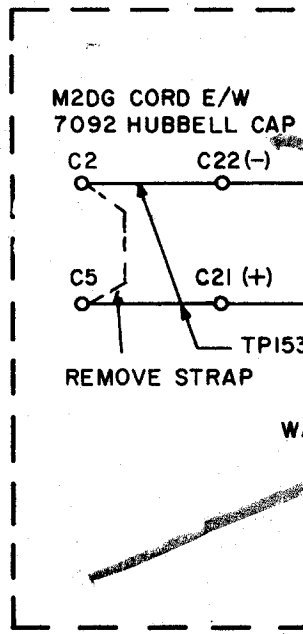
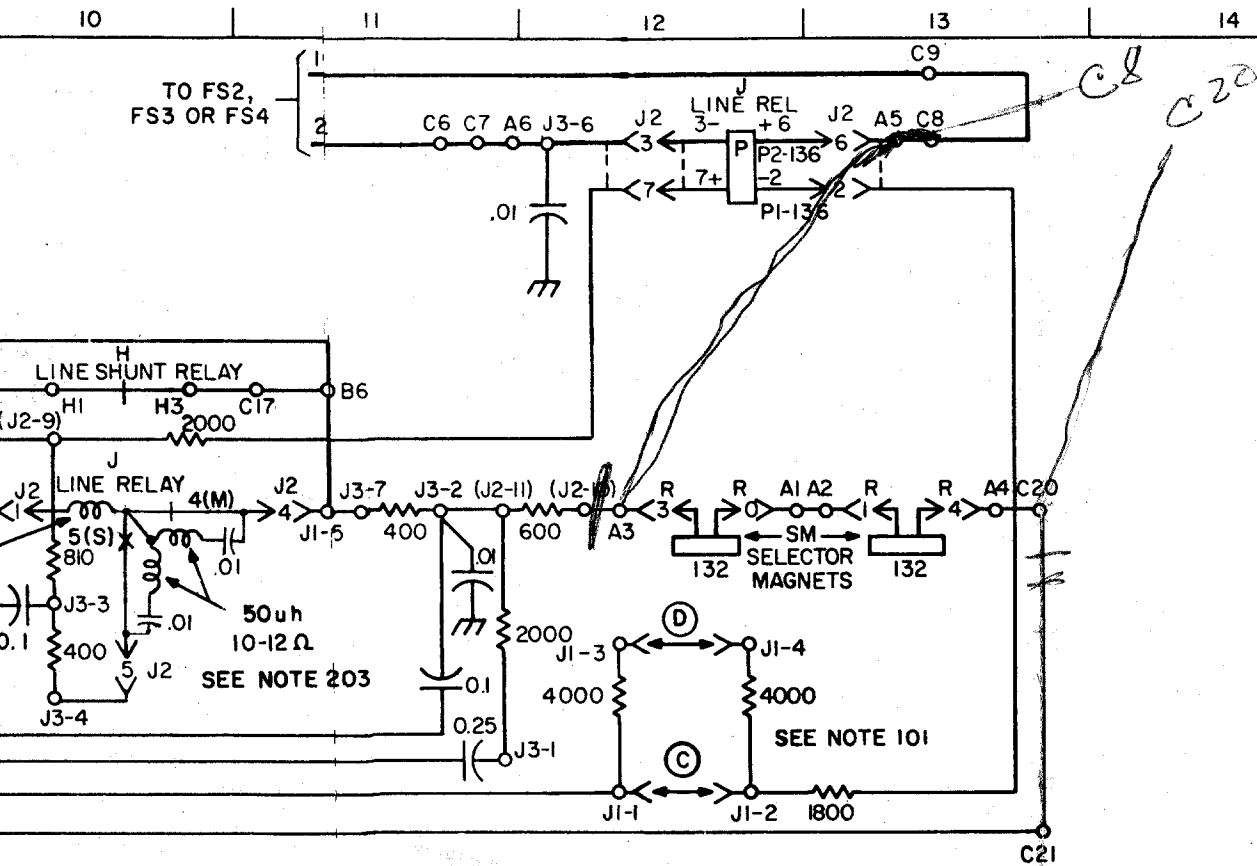

FIG. A
60V COPY LAMPS IN SERIES

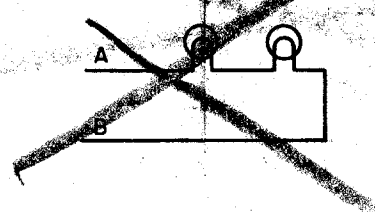

FIG. B
60V COPY LAMPS IN PARALLEL

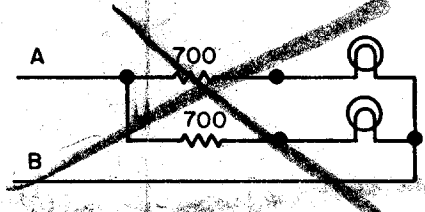
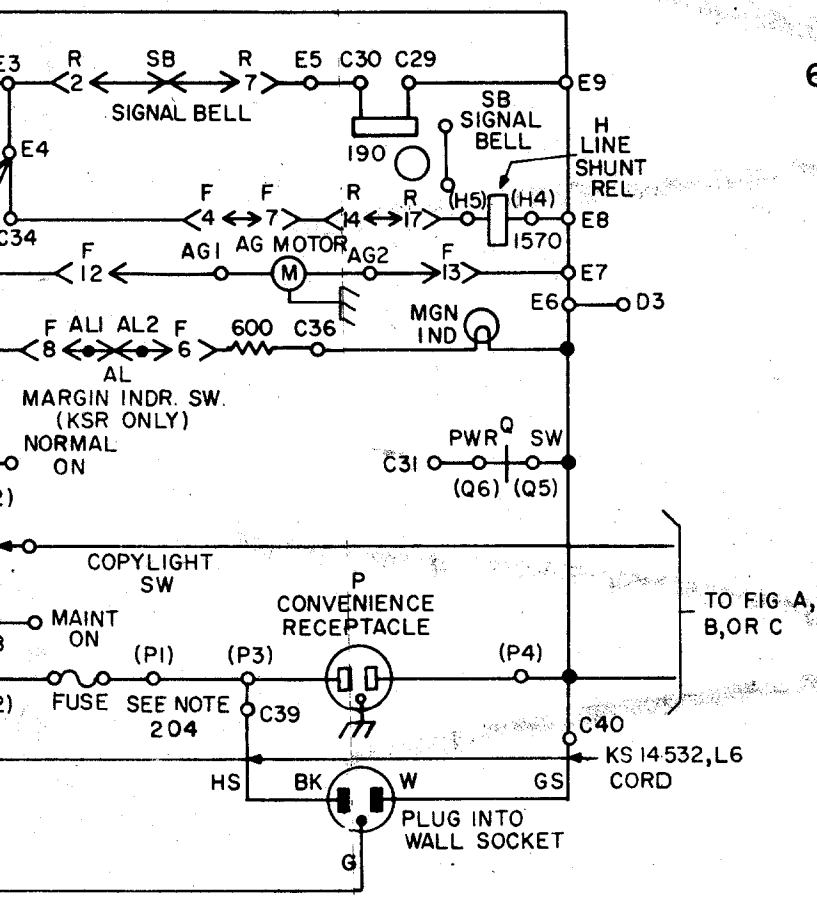
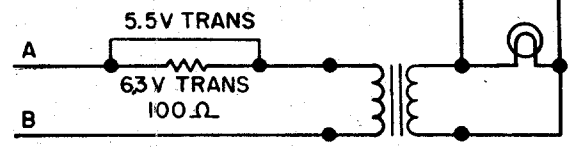
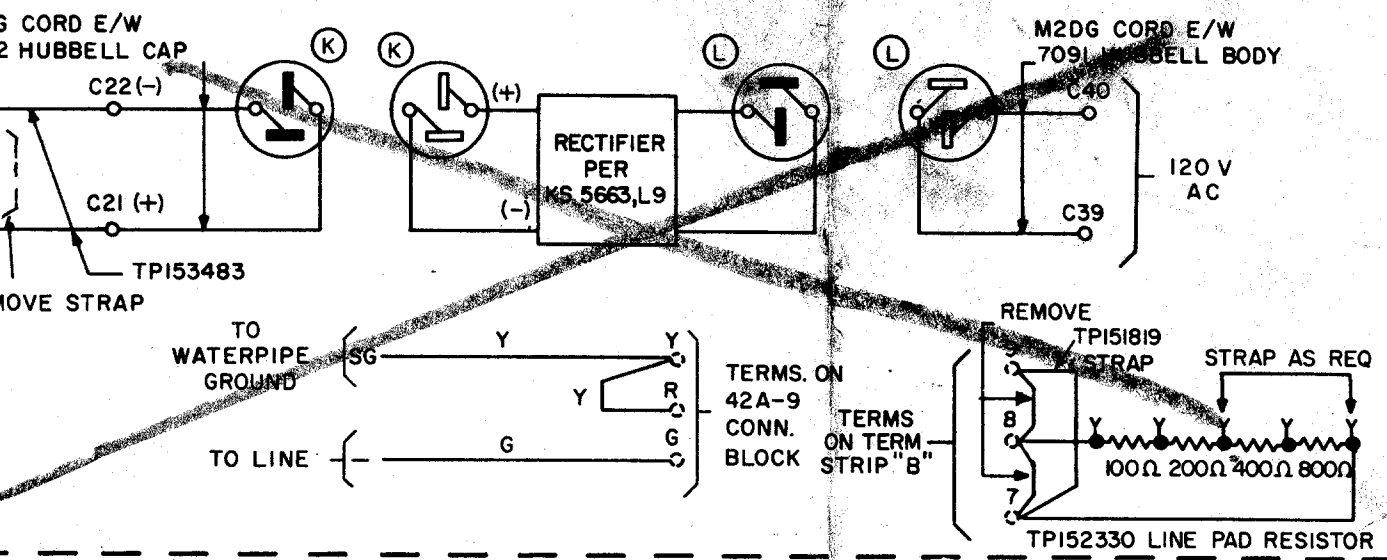

FIG. C
6V COPY LAMPS WITH TRANSFORMER



MODIFICATION FOR POS BAT. AT TTY TO LINE



MODIFICATION FOR NEG. BAT. AT TTY TO LINE OR TO SUPPLY LINE BAT. AT AN INTERMEDIATE STATION OR FOR METALLIC OPERATION

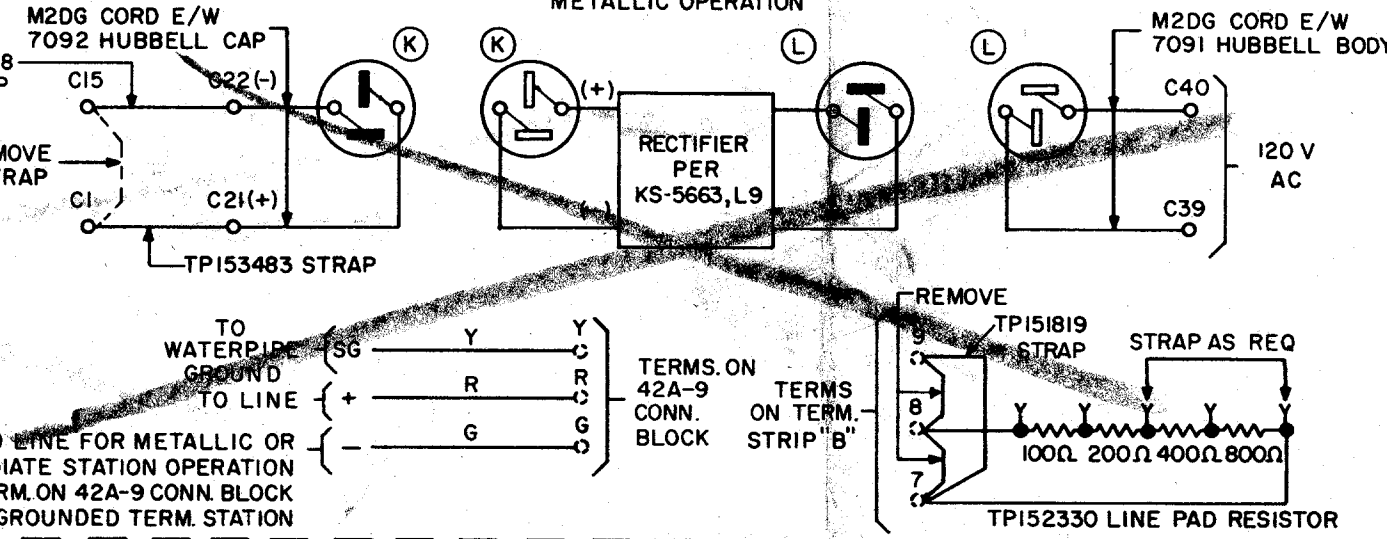

EXTERNAL LINE CONNECTIONS

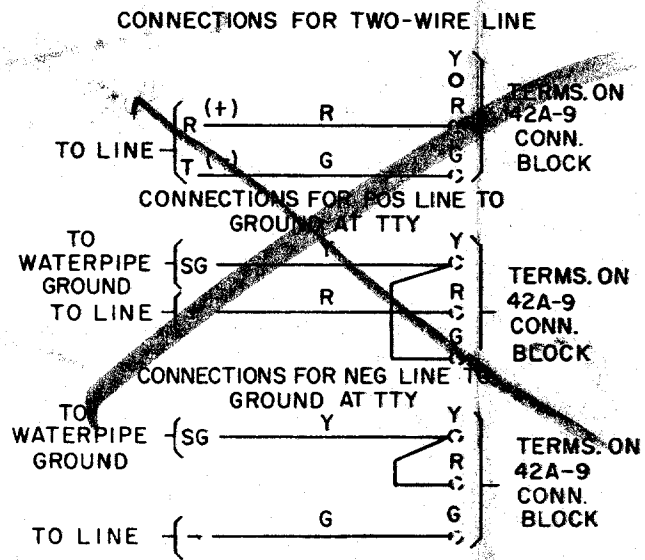

WESTERN ELECTRIC
Product Engineering
Teletype Corporation

W0470
28 TYPE TWPL
KEYBOARD SEND-RECEIVE
LINE RELAY - SW
NEUTRAL OR POLAR

SHEET
TP-581.000

W0470
SHEET B1

POS BAT. AT TTY TO LINE

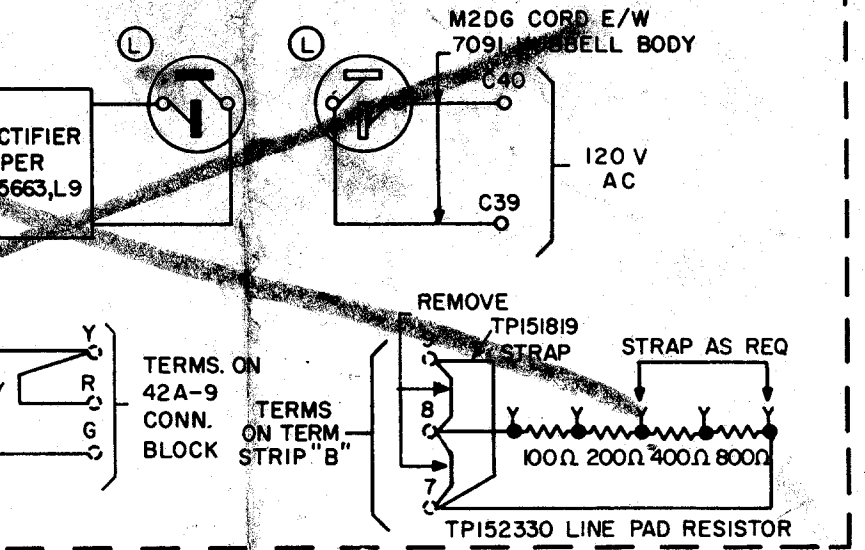

NEG. BAT. AT TTY TO LINE OR TO AN INTERMEDIATE STATION OR FOR METALLIC OPERATION

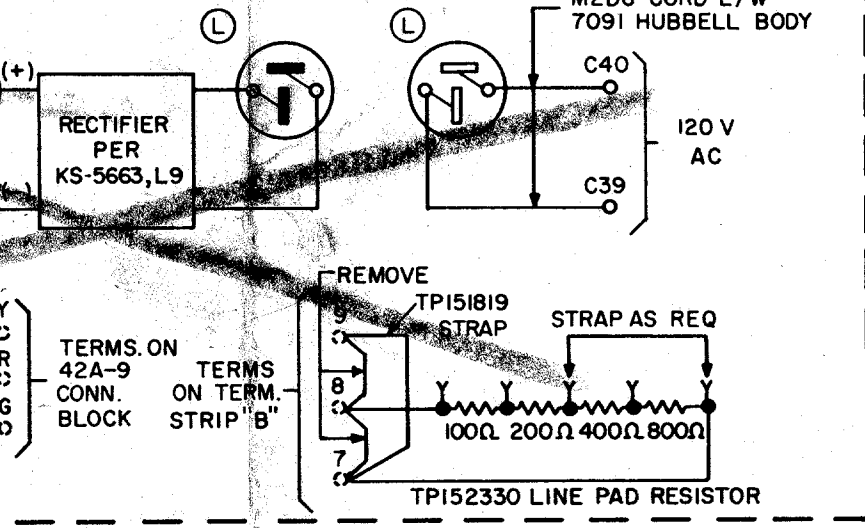

GENERAL LINE CONNECTIONS

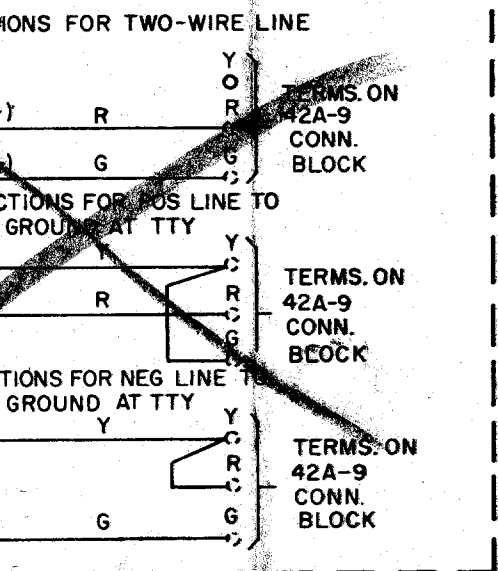

DRAWING ISSUE		
ISSUE	DATE	SIGN
1	11-15-63	EHT
2	12-1-66	JTS

WESTERN ELECTRIC COMPANY, INC.
Product Engineering Control Center
Teletype Corporation

W0470
28 TYPE TWPL SERVICE
KEYBOARD SEND-RECEIVE OR RECEIVE-ONLY
LINE RELAY - SWITCH CONTROL
NEUTRAL OR POLAR - AC 60 CYCLES
SHEET B1
TP-581.000 FILE IN BOOK 4C